



MORRIS GROUP
INTERNATIONAL®





WWW.MORRISGROUP.CO

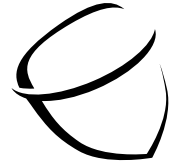

MORRIS GROUP
INTERNATIONAL®

2.5 MILLION
OVER 2.5 MILLION SQUARE FEET OF
MANUFACTURING, WAREHOUSE,
AND OFFICE SPACE

2,000+
EMPLOYEES

STRENGTH IN NUMBERS

From the founding vision of Earl L. Morris to the 2,000 employees that make up MGI today, the creativity, ingenuity, dedication, and drive from each and every employee is what makes us who we are.



28 DIVISIONS & PARTNERSHIPS

20 MANUFACTURING DIVISIONS

WATER CONTROL

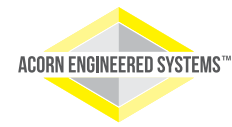

PLUMBING FIXTURES AND ACCESS



Whitehall Manufacturing

DRAINAGE



FIRE PROTECTION



MANUFACTURING SUPPORT



THE HIGHEST STANDARDS

We design, engineer, and manufacture products with precision to meet today's construction and installation trends, including modular design and prefabricated installation, universal design, infection prevention, water control, and much more.

8 SALES AND DISTRIBUTION DIVISIONS



UNITED ARAB EMIRATES



MORRIS/LEE LTD CANADA

27 LOCATIONS WORLDWIDE

Morris Group International boasts 27 locations worldwide. With manufacturing facilities spread out over North America and distribution centers located worldwide, we can swiftly ship products wherever they are required.

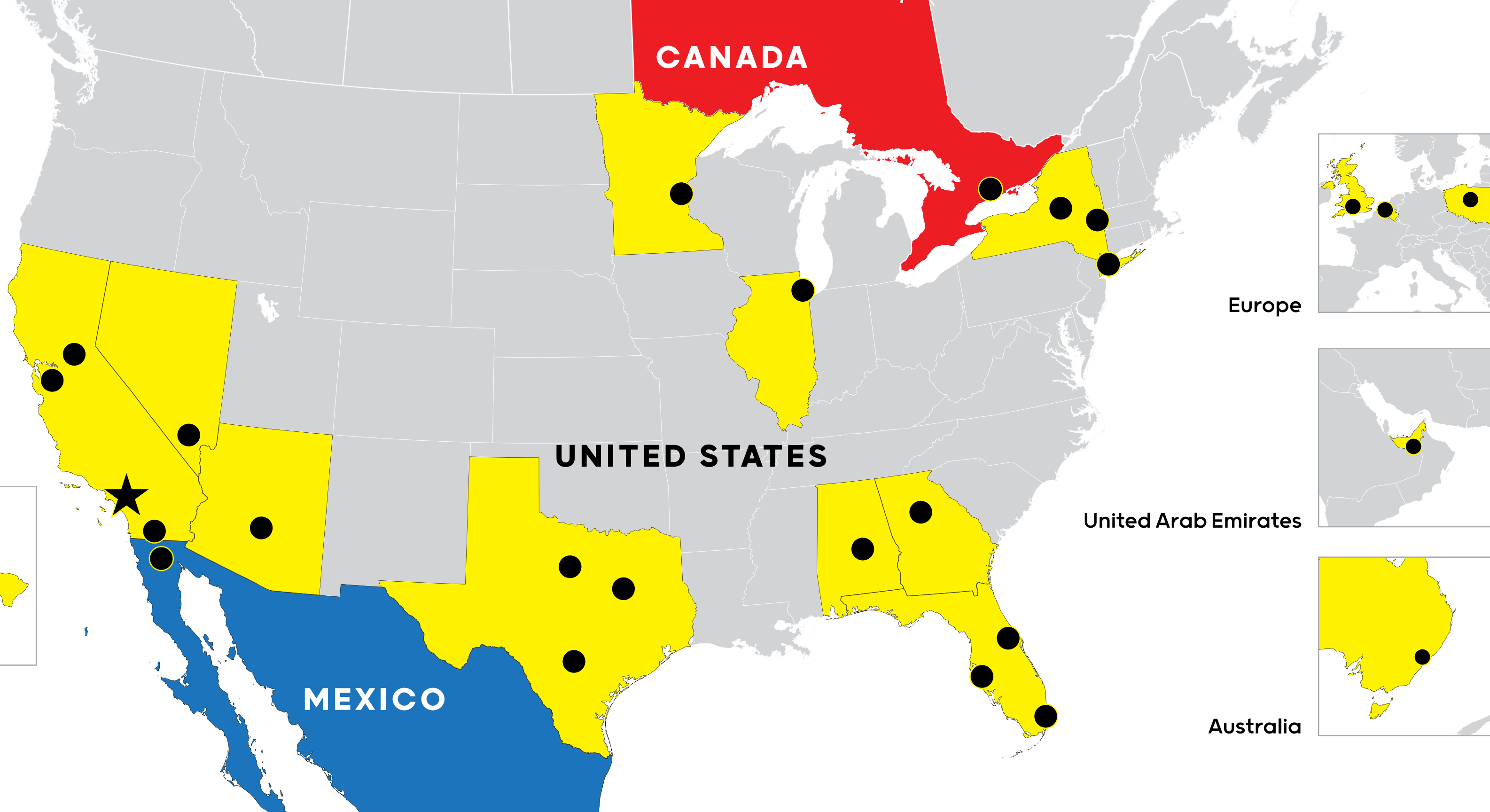

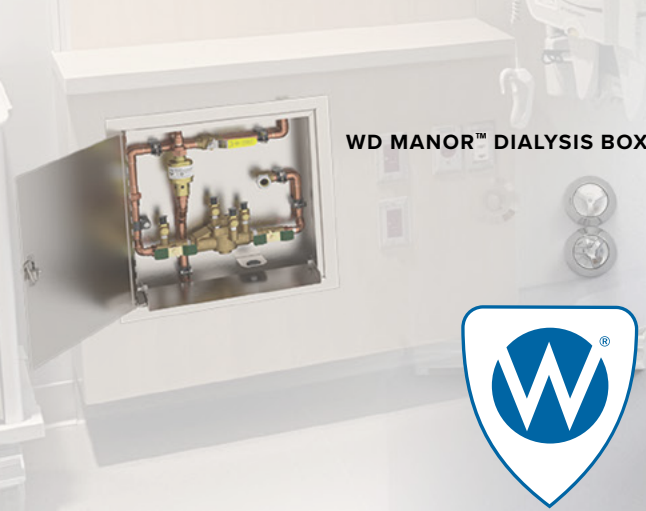

WD MANOR™ DIALYSIS BOX



Whitehall Manufacturing



BESTCARE™ DIGNITY SUITE



ECO-TROUGH™ HAND WASHING STATION



VARI-SLAB™ BASIN

ELLIPSE™ WASH STATION



SLAB EDGE™ BASIN

CMI SERIES



PORTABLE WASH-WARE™



DELUXE WASH TROUGH™



ALPHA™ THERMOSTATIC MIXING VALVE

OMEGA™ THERMOSTATIC MIXING VALVE



LABOR SAVING PRODUCTS



FLUID CONTROLS™ TRAP PRIMER



SMITH™



ZIP-TRENCH™ TRENCH DRAINS



DELUXE TROUGH™ WITH BOTTLE FILLERS

OUTDOOR WASH-N-GO™ SERIES



EZ REACH™ BOTTLE FILLER



MORRIS GROUP INNOVATIONS



ACORN SINCE 1954

ENGINEERING COMPANY®



WWW.ACORNENG.COM

SECUR-CARE
LIGATURE-RESISTANT PRODUCTS

Designed to protect inmates while in the justice system as well as help them transition to normal life. This transition begins with the individual living units.



HIGH EFFICIENCY REAR-MOUNTED
STAINLESS STEEL SECURITY URINAL
MODEL NO. LR1709FG



15" STAINLESS STEEL LAV-TOILET
COMBY WITH ROUND LAVATORY BOWL
LR1415 Series



ADA-COMPLIANT STAINLESS STEEL
SECURITY LAVATORY WITH OVAL BOWL
MODEL NO. LR1652



Justice Furniture
by Acorn Engineering Co.

Prison furniture for correctional applications.



MULTI-USER HAND WASH STATION
MODEL NO. 3506-F



M1 NEO-METRO
 by ACORN®
VARI-SLAB®
MODEL NO. 9220

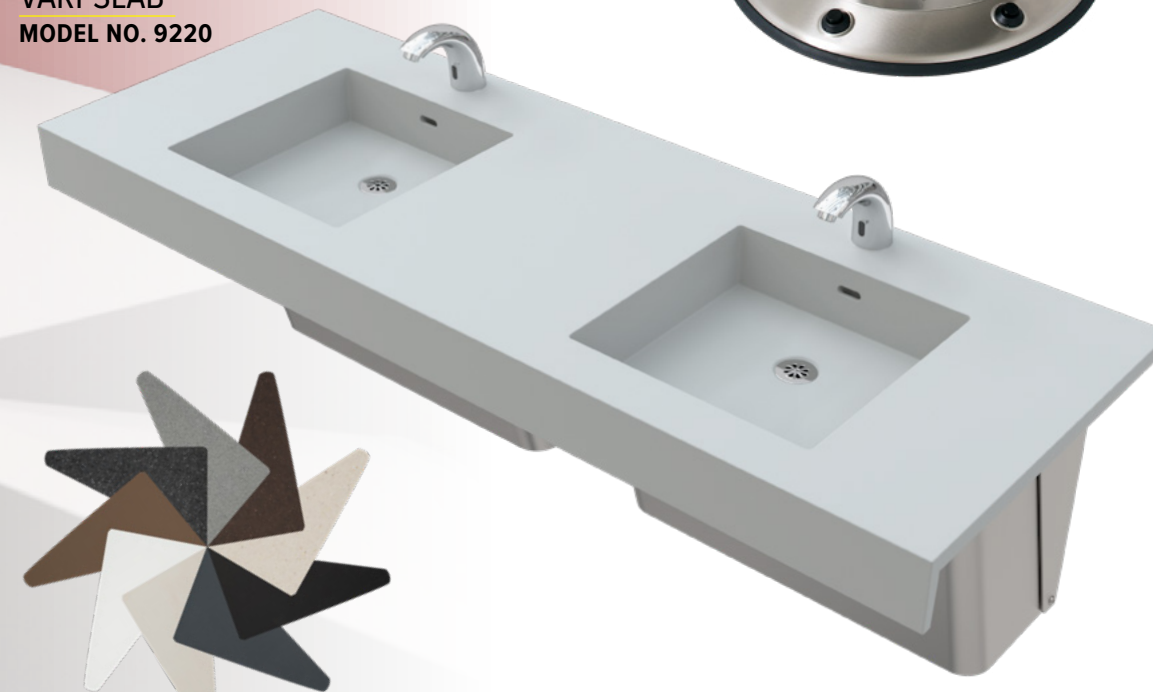

WWW.ACORNENG.COM



HAND WASH STATIONS AND BASINS

Acorn® washbasins offer durability, style, and flexibility when outfitting commercial restrooms. Single units made of heavy-gage stainless steel are ideal for institutional and commercial applications. Multi-user stations are available in a variety of materials and designs, including stainless steel and solid surface.

Our newest addition to the handwashing product line, Vari-Slab® Configurable Basins, is designed to streamline the specification process and make placing an order as easy as 1, 2, 3! Choose a length—from one to four stations—to suit your needs; a bowl shape—square, rectangular, round or oval—to suit your aesthetic; and a color to suit your décor.

SINGLE USER PORTABLE AND STATIONARY HAND WASH SINKS
PS1000 SERIES



Trash Can

Paper Towel Holder



WWW.ACORNENG.COM

SHOWER-WARE®

With an emphasis on durability, Shower-Ware fixtures are crafted from heavy gauge stainless steel and are designed to maximize the available space to simultaneously accommodate as many bathers as possible. Applications range from commercial and parks and recreation settings to institutional environments like hospitals, schools, and correctional facilities.

The wide variety of configurations and options give Acorn® showers the flexibility to meet the needs of any application. Choose from surface-mounted, flush-mounted, corner, back-to-back, column, and multi-station models.



FLUSH MOUNT STAINLESS STEEL APEX SHOWER
MODEL NO. 410B



ADA, MODULAR STAINLESS STEEL WALL MOUNT ACME SHOWER
110ADA Series



CAPITAL STAINLESS STEEL COLUMN SHOWER
700 Series

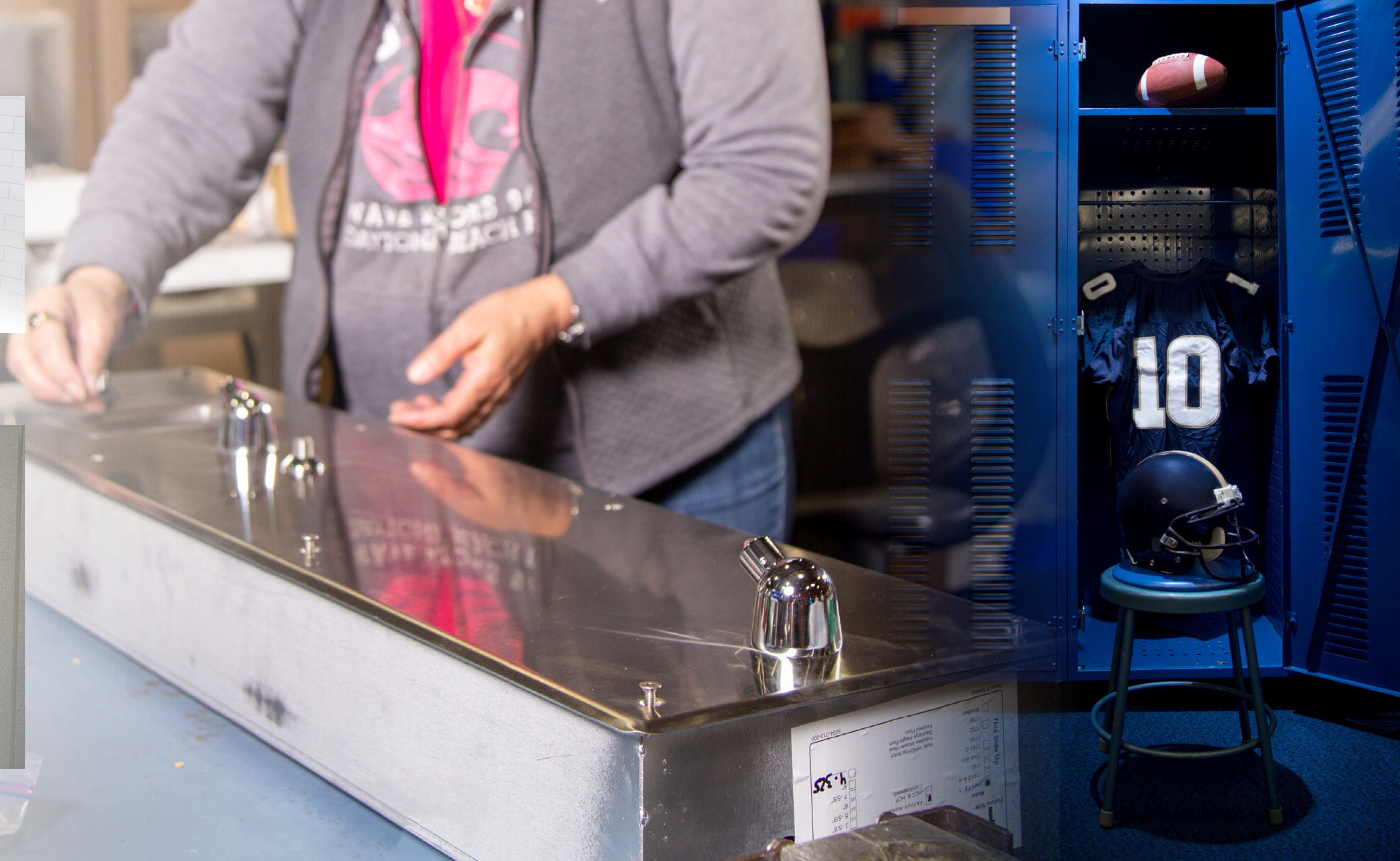

JSW J500EII

WWW.ACORNBEE.COM

ACORN[®]
BEEKEEPING EQUIPMENT



Acorn Beekeeping Equipment was started in 2013 to satisfy the needs of commercial, sideline, and backyard beekeepers worldwide. We had one goal—design and produce the highest quality one-piece plastic bee frames, foundations, and drone combs on the market.

in healthcare products? Still, the greatest contribution bees make is the pollination of nearly three-quarters of the plants that produce 90% of the world's food.

All of our products are custom molded and waxed in our California plant. We use only 100% pure, high-quality beeswax. Our commitment to quality is why we sell over one million frames and foundations each year, and why our products are used around the world.

We think that bees deserve the best because of the vital role they play in human survival. Everyone knows that bees produce high-quality food—honey and jellies. But did you know that beeswax, propolis, and honey bee venom are used

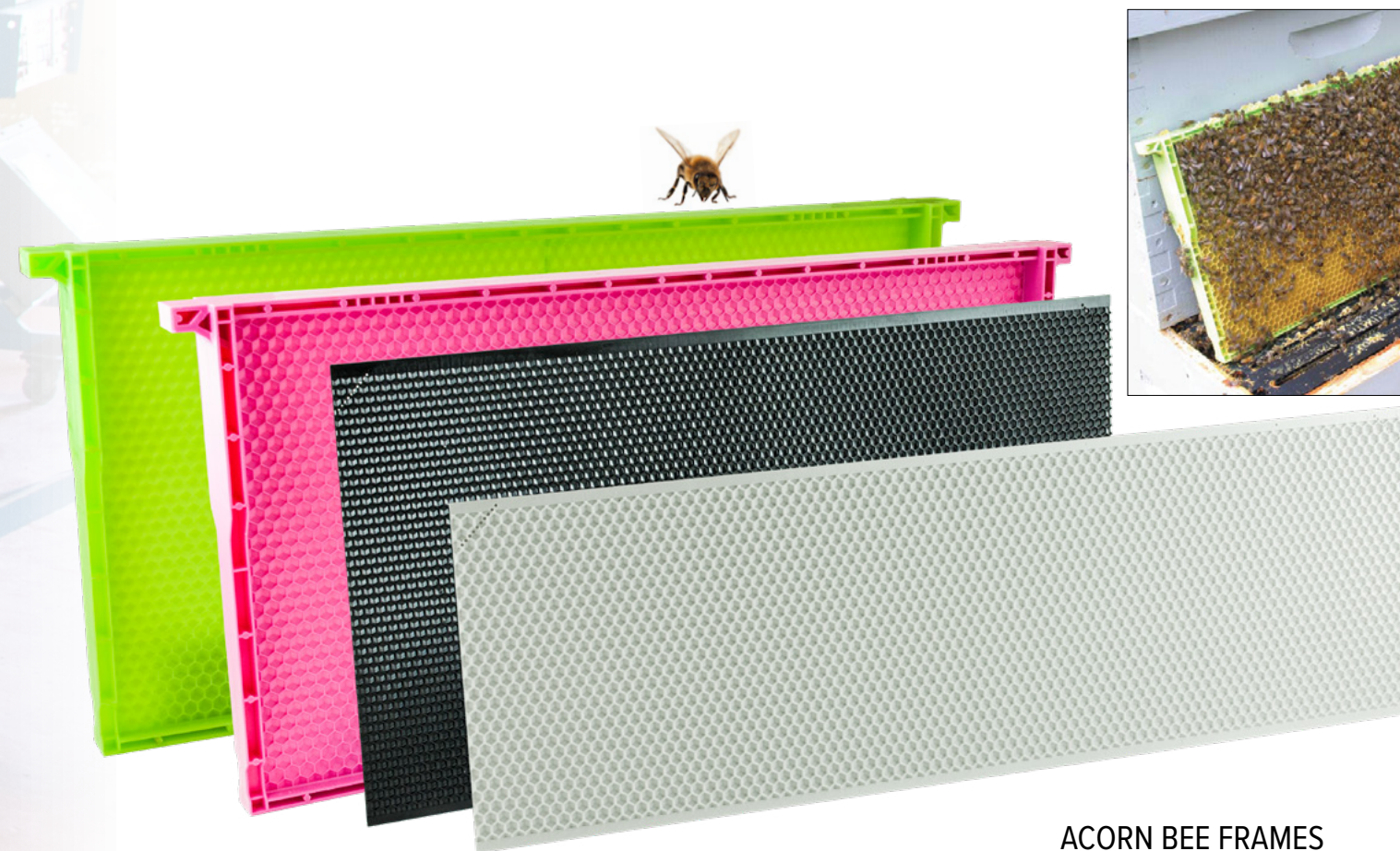

ACORN BEEKEEPING EQUIPMENT[®]

SINCE 2013

ACORN BEE FRAMES

Acorn-Gencon started out molding all the plastic parts for the MGI family of companies. For over 20 years, we've been providing complete injection molding solutions, from concept to completion, for enterprise-level manufacturers to entrepreneurs.

With one of the industry's most substantial diversity in press sizes, we are equipped to provide precision molding with tight tolerances for the electronics industry as well as large-tonnage molding.

For companies looking to have parts manufactured in the USA, we offer a unique advantage. We are located just outside of Los Angeles, California—just a short distance away from major ports and distribution centers.

Besides molding, we also do assembly, packaging, warehousing, and with Amazon distribution centers just 20 minutes from our facility, we can run drop shipments direct each day, making us a one-stop shop for entrepreneurs.

Whether you are looking for component parts or finished products, we operate 24 hours a day, five days a week, enabling us to provide prompt turnaround on all orders.



MURDOCK® MANUFACTURING H2O-To-Go®
INDOOR BOTTLE FILLER BACKSPLASH



WHITEHALL® MANUFACTURING
LIGATURE-RESISTANT TOILET SEAT



ACORN-GENCON PLASTICS

SINCE 1972



Accidents in the workplace happen. While we hope you will never have to use your safety system, we know how important it is for the equipment to work when needed.

Acorn Engineered Systems provides indoor and outdoor water tempering and emergency drench systems for a variety of industries. We specialize in creating systems for water treatment and petrochemical plants, healthcare and pharmaceutical operations, manufacturing facilities, power generation and utility operations, and high-tech manufacturing facilities.

We understand that each facility is unique and faces its own plumbing challenges. There are times when off-the-shelf safety products are not adequate for the situation. That's where we excel.

We work directly with design engineers and architects to design and customize specially tailored watering tempering system for your facility.

OUTDOOR BOOTH TEMPERING SYSTEM



OUTDOOR SKID-MOUNTED TEMPERING SYSTEM



SKID-MOUNTED TEMPERING SYSTEM W/ DRENCH SHOWER



ACORN ENGINEERED SYSTEMS[®]

SINCE 2017

When we launched Acorn Controls in 2013, we didn't just want to improve on what was already available. Our goal from the very beginning was to start from scratch and re-think controls completely.

What we accomplished in that short time was the engineering and production of the best controls available to ensure bather safety and comfort. Our controls and valves are also easy to maintain and have a low cost of ownership despite their complexity.

Today, our focus is on digital solutions that alert the building owner to problems of which they would otherwise be unaware.

This way, instead of performing maintenance on a fixed schedule whether the equipment needs it or not, maintenance can be performed on a facility's preferred schedule.

We continue to invest in innovations (such as sensors to detect anomalies or dangerous bacteria and viruses in water) in order to further deliver on our promise of safety and comfort.



COMMAND STATION WITH **BASyC**[™]
MODEL NO. CSMV SERIES



Alpha[™]

PLASTIC TEMPERING VALVE
MODEL NO. STP7069

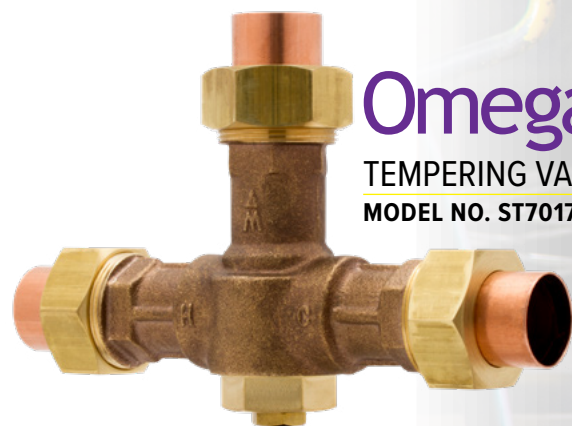

Omega[™]

TEMPERING VALVE
MODEL NO. ST7017



THERMOSTATIC MIXING VALVE
MODEL NO. ET71-3



ACORN CONTROLS SINCE 2013



Acorn Safety is a proud manufacturer of the industry's leading emergency drench equipment and safety plumbing products. Typical customers in the commercial and industrial markets include hospitals, pharmaceuticals, manufacturing plants, utility and maintenance rooms, laboratories, and more. They turn to us because of the reliability of our products.

All of our safety products are constructed of stainless steel and anti-microbial plastics, materials that provide durability to emergency tempering fixtures. All of these are capable of integrating with an industry first digitally controlled emergency tempering system.

A safety shower or eye wash station is something you hope you never need to use, but it is crucial for it to work when you need it. We understand and value the importance of these products, and we will continue to invest in new technology. Enhancements such as automatic testing and alerts are on the horizon, which will provide our customers with additional protection.

ACORNSAFETY.COM



HEAT-TRACED PLASTIC
HEAD PEDESTAL SHOWER
WITH EYE/FACE WASH, LESS BOWL
MODEL NO. S1360-HT



STAINLESS STEEL BOWL, PEDESTAL EYE/FACE
WASH WITH HAND/FOOT CONTROL
MODEL NO. S0340-HFC



RECESSED, SWING-DOWN EYE/FACE WASH
MODEL NO. S0560

ACORN SAFETY[®]

SINCE 2008



ACORNVAC.COM

When we started vacuum plumbing back at the turn of the new millennium, AcornVac's inherent security advantages made correctional facilities a natural area of focus, while its flexibility made it an ideal solution for grocery stores. Today, however, we have a presence in almost every market.

This widespread presence is because architects, building owners, and contractors understand the value of vacuum plumbing. It is a portable, flexible plumbing infrastructure that offers solutions for challenging projects. Those challenges can be due to site conditions, structural issues, or even just tenants who cannot be disrupted by construction going on above them.

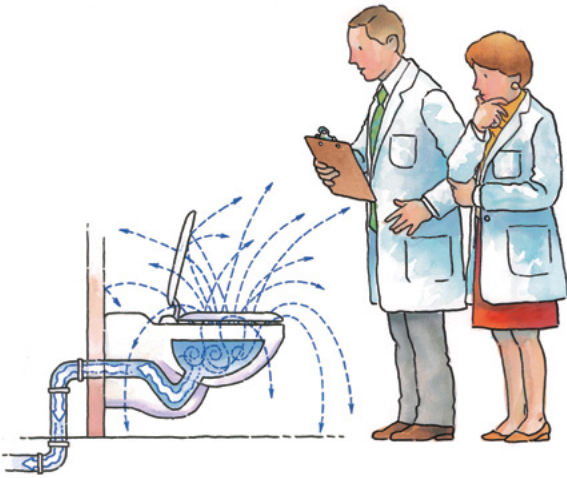

AcornVac Plumbing Systems include toilets that are designed to eliminate splash and plume by drawing air into the toilet with every flush.



Healthcare institutions favor AcornVac systems because vacuum plumbing promotes a healthier environment. Our waste piping doesn't leak, and our toilets do not produce unsanitary flush plumes.

We believe that as more people discover the convenience of vacuum plumbing, it will be the new basis of design for plumbing and drainage.

CREATING A NEW BASIS OF DESIGN IN PLUMBING AND DRAINAGE

A versatile plumbing solution that moves waste up and out.



ACORNVAC[®]

SINCE 2000



Since 1966, Chronomite has engineered and manufactured point-of-use electric water heaters for the commercial and residential market.

Every single part of our robust, energy-efficient water heaters is made right here, in North America, by us. This means components, such as flow switch mechanisms, are consistent throughout our entire line of heaters.

Not only do our customers—owners of multi-unit dwellings, hotels, and institutional, hospital, and commercial properties—turn to us for an energy-efficient solution, they recognize our safety value as well.

Chronomite water heaters add a layer of protection against the spread of Legionella, a growing problem around the world. Lukewarm standing water is an ideal breeding ground for this dangerous bacteria. By heating water at the point of use, Chronomite® water heaters minimize the amount of warm water lying in the pipe and help to prevent the spread of Legionella.

Ideal Applications:

Manual, metering, or sensor handwashing faucets; dual hand washing sinks; kitchen sinks; bar sinks; utility sinks; water saving showers; standard showers; dishwashers; washing machines; mop sinks; bathtubs; emergency eye washes; and emergency eye/face washes.

BOXER® WATER HEATER
ERB Series



MightyMite
WATER HEATER
R Series (as shown, left)

COMPLIANTMIX® WATER HEATER
CMI Series



INVIZIBLE™ WATER HEATER
Z Series



CHRONOMITE [®]
 SINCE 1966

Elmdor's quality, availability, and service have customers from just about every market imaginable coming to us again and again whenever they need access doors and roof hatches. With our extensive inventory and range of stock available, we can have your part on a truck the same day you order it.

Besides stock orders, we welcome and accommodate custom orders. Every door we make starts in our North American factories as a custom sheet of steel. It is then fabricated, boxed, and shipped from the same location.

We intend to continue producing high-quality stainless steel products that our customers love. We will also continue investing in new product development and expanding to new markets to serve our customers no matter where their project is located.

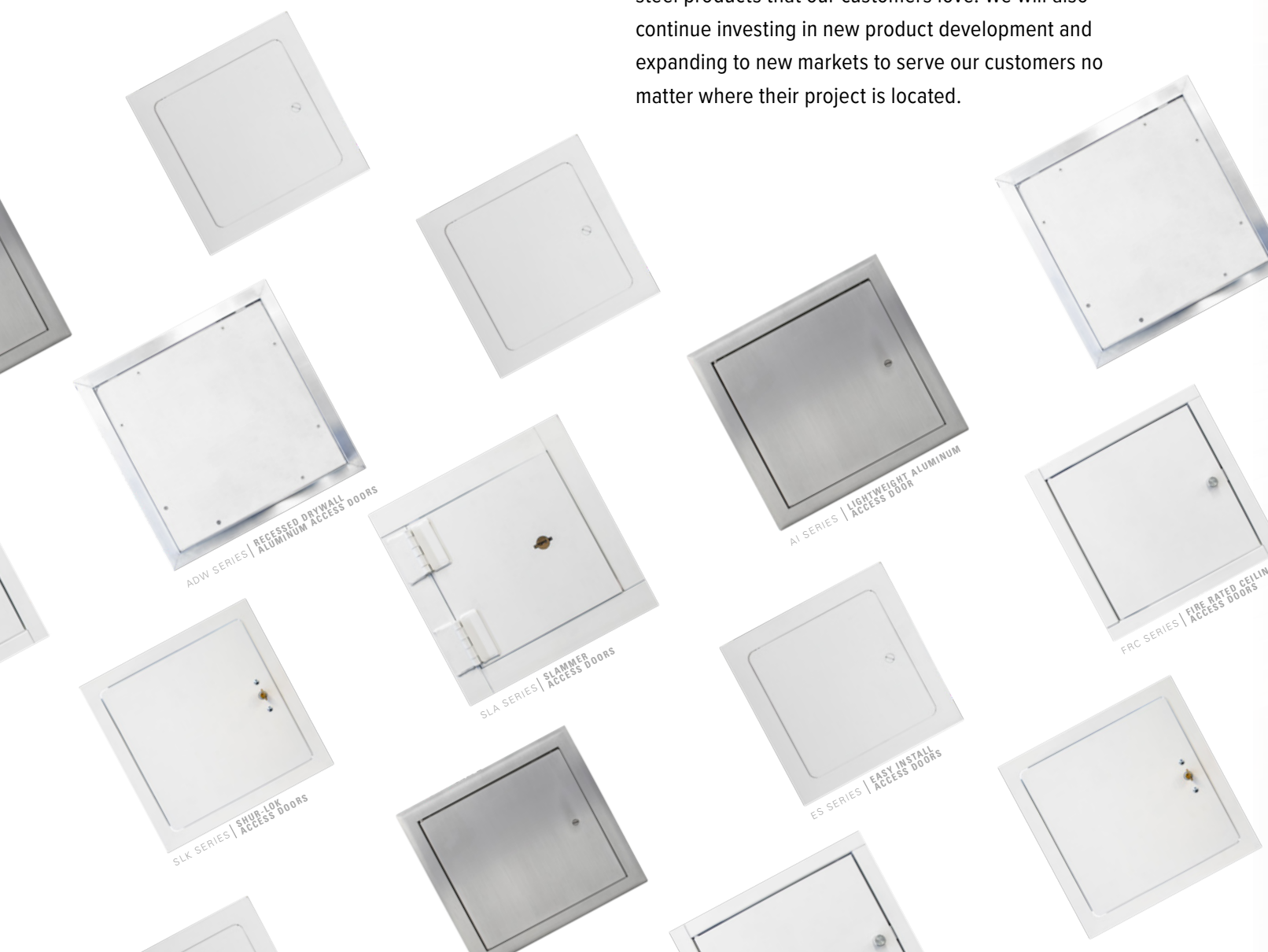

FIRE PRO[®]

SINCE 1979

POTTERROEMER.COM/FIRE-PRO-EQUIPMENT



Since our inception in 1979, Fire Pro's mission has been to manufacture quality fire protection products at an affordable price with short, reliable lead times. That still holds true today and is part of what makes us a thriving division of Morris Group International.

Our monitors are essential fire protection equipment in the mining industry, oil refineries, marine applications, wastewater plants, wildland vehicles, chemical and petrochemical settings, and more—but our equipment is also used for dust abatement, cleaning, and many other tasks that require precise, high-flow water delivery.

We recognize that every application needs the right solution. For many customers, we can meet their needs with one of our standard, existing products. For others, we will go out of our way to design and create a custom product that precisely addresses their needs.

From conceptualization and design to installation, calculation, troubleshooting, and even maintenance, we're happy to work with you. If you need 100 units or a one-off, custom-tailored system, we guarantee you the best in support, reliability, and value.



MANUAL MONITOR
FIGURE NO. FP4S-750



CHARGER MONITOR
FIGURE NO. FP750C



HYDRAULIC MONITOR
FIGURE NO. FP3-750-HYD



MORRISINDUSTRIES.COM.MX

Fabricación y Manufacturas de México S.A. de C.V. is the Mexican manufacturing facility of Morris Group International. With 600 employees and 400,000 square feet of manufacturing and office space, F&M México provides essential manufacturing power to Morris Group International.

F&M México specializes in products fabricated from stainless and galvanized steel, terrazzo, plastic, solid surface materials, and cast iron. Our manufacturing capabilities include fabrication, assembly, wet and powder coating, and polishing. Products made at F&M México are distributed throughout Mexico by Morris Industries Mexico.

We pride ourselves in our ability to create high-quality, unique, custom solutions for customer needs. Morris Industries Mexico supplies fixtures to schools, correctional institutions, and commercial and government buildings.

F&M México has received several awards in recognition of our commitment to quality manufacturing practices, and, with Morris Industries Mexico, continues to lead the industry in producing high-quality, beautiful, and durable fixtures.

FABRICACIÓN Y MANUFACTURAS DE MEXICO S.A. DE C.V.® SINCE 1989





JRSMITH.COM

Today, Jay R. Smith Mfg. Co. boasts more than 65 service centers around the world—but in 1926, it was just an idea. A salesman for the National Lead Company, Jay L. Smith saw a market need for quality plumbing products. He enlisted the aid of his son, Jay R. Smith, and an industry leader was born.

Today, Smith® produces a wide range of innovative industrial plumbing products spanning everything from floor drains to electronic trap primers. Thanks to our long history in the industry and the expertise of our engineers, we understand many of the challenges facing our customers. Our Labor Saver® line is specially designed to minimize many of these frustrations.

We at Smith pride ourselves on being customer driven. We never turn down a challenge, specifically when it offers us the opportunity to create a custom product to fit a customer's needs. No matter what that challenge is, we rise to meet it.

JAY R. SMITH MFG. CO.® SINCE 1926

6" WIDE MODULAR STAINLESS
STEEL TRENCH DRAIN SYSTEM
FIGURE NO. 9660





DOWNSPOUT WITH HINGED COVER
FIGURE NO. 1775

STAINLESS STEEL

Jay R. Smith Mfg. Co. offers a full line of stainless steel drainage products. Stainless steel offers a superior appearance and resists stains and corrosion, making it the ideal material for drains in food service, food processing, and industrial manufacturing plants, including pharmaceutical environments.

GENERAL PURPOSE FLOOR DRAIN WITH ADJUSTABLE STRAINER HEAD
FIGURE NO. 9600

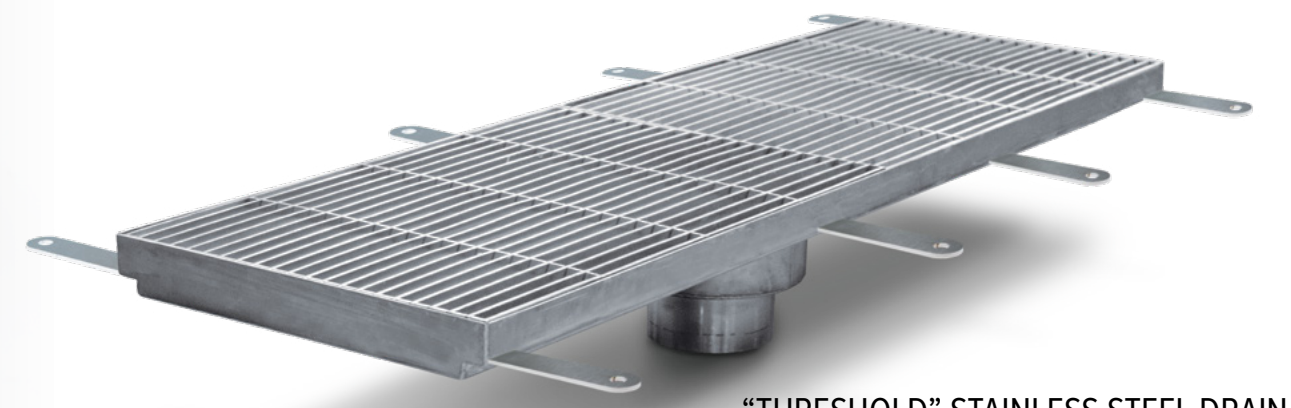

"THRESHOLD" STAINLESS STEEL DRAIN
FIGURE NO. 9679



JRSMITH.COM



TRENCH DRAINS

Jay R. Smith Mfg. Co.'s line of trench drainage systems includes polypropylene Zip-Trench®, the Smith/ACO line of polymer concrete and fiberglass trench drains, stainless steel trench drains, and the Enviro-Flo® II polypropylene trench drain system.



6" WIDE POLYPROPYLENE
TRENCH DRAIN SYSTEM
FIGURE NO. 9940

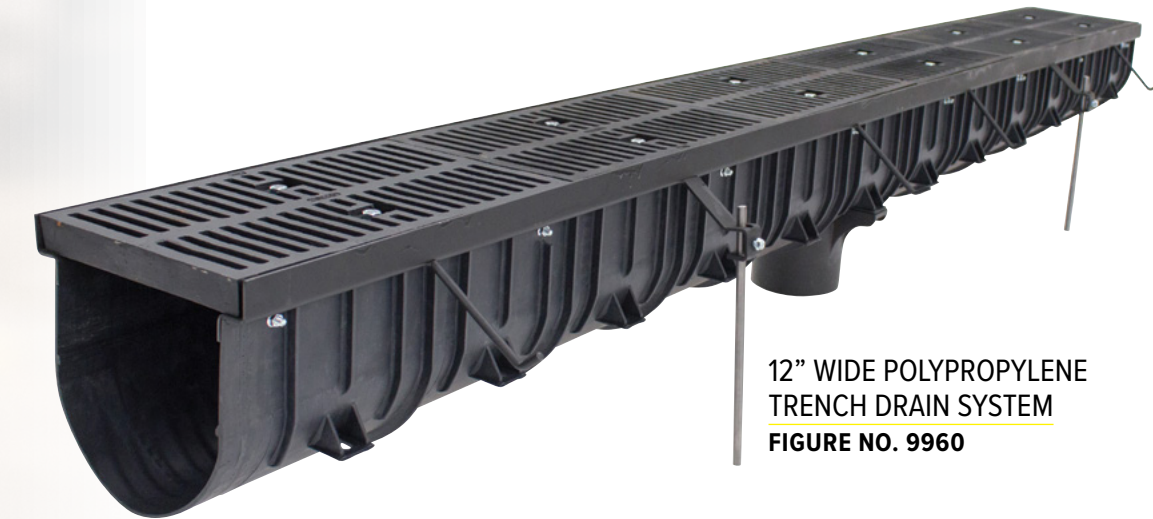

12" WIDE POLYPROPYLENE
TRENCH DRAIN SYSTEM
FIGURE NO. 9960



JRSMITH.COM

TRAP PRIMERS AND DISTRIBUTION UNITS

Smith's Fluid Controls line of products encompasses several different product types and features the Trap-Defender™ trap primer. This pressure-drop trap primer features virtually no moving parts, making it unique in the industry.

Other products include electronic trap primers, distribution units, trap primer valves and adapters, air gap and dielectric fittings, and water hammer arresters. Access doors are also offered as part of the Fluid Controls line, providing attractive, easy access to hidden components for service and maintenance while presenting an attractive exterior.



TRAP PRIMER (NICKEL)
FIGURE NO. 2694-NP



TRAP PRIMER
FIGURE NO. 2694

CLOVERLEAF STYLE
DISTRIBUTION UNIT
FIGURE NO. 2694DA-ABS-625

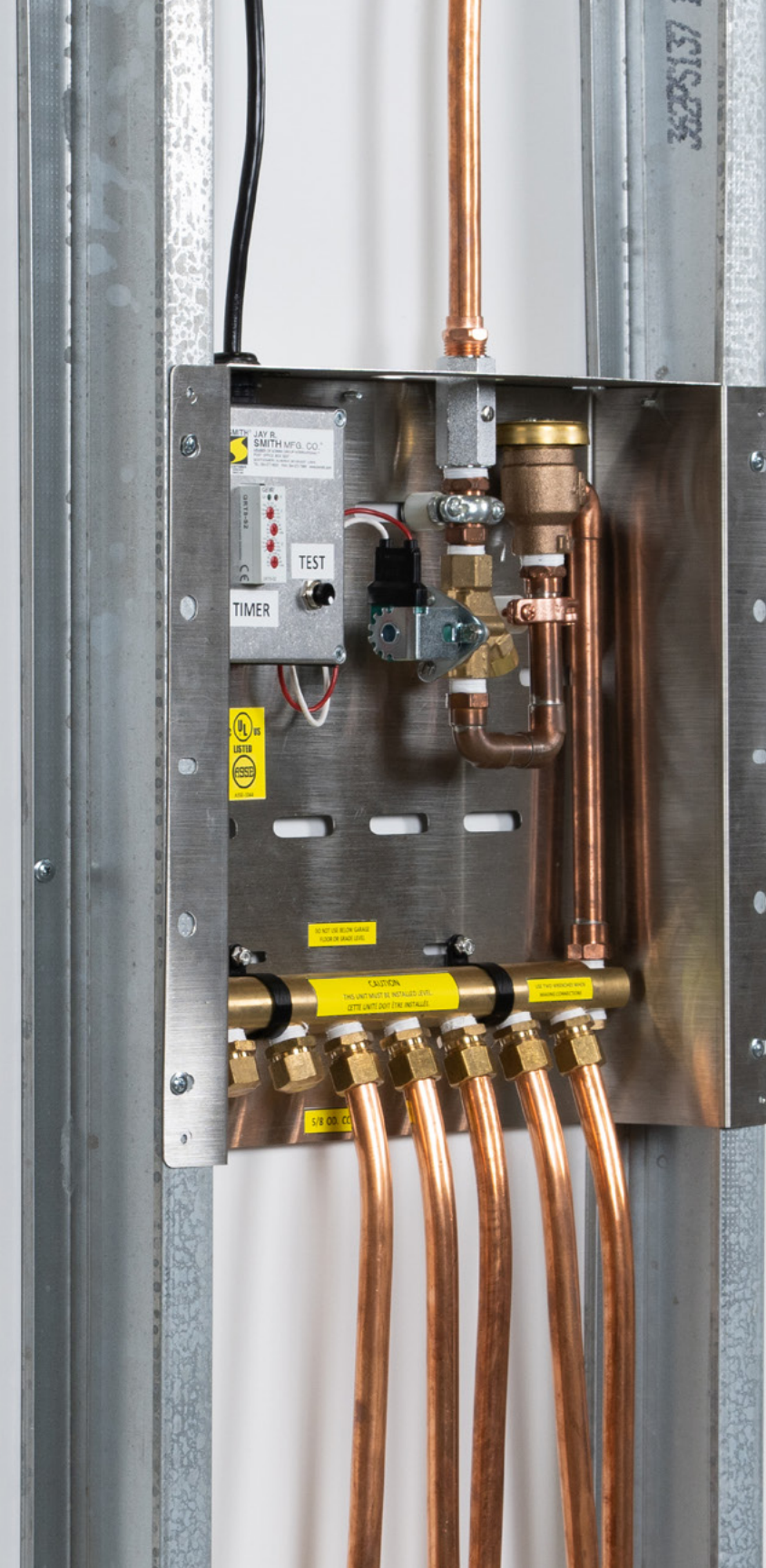
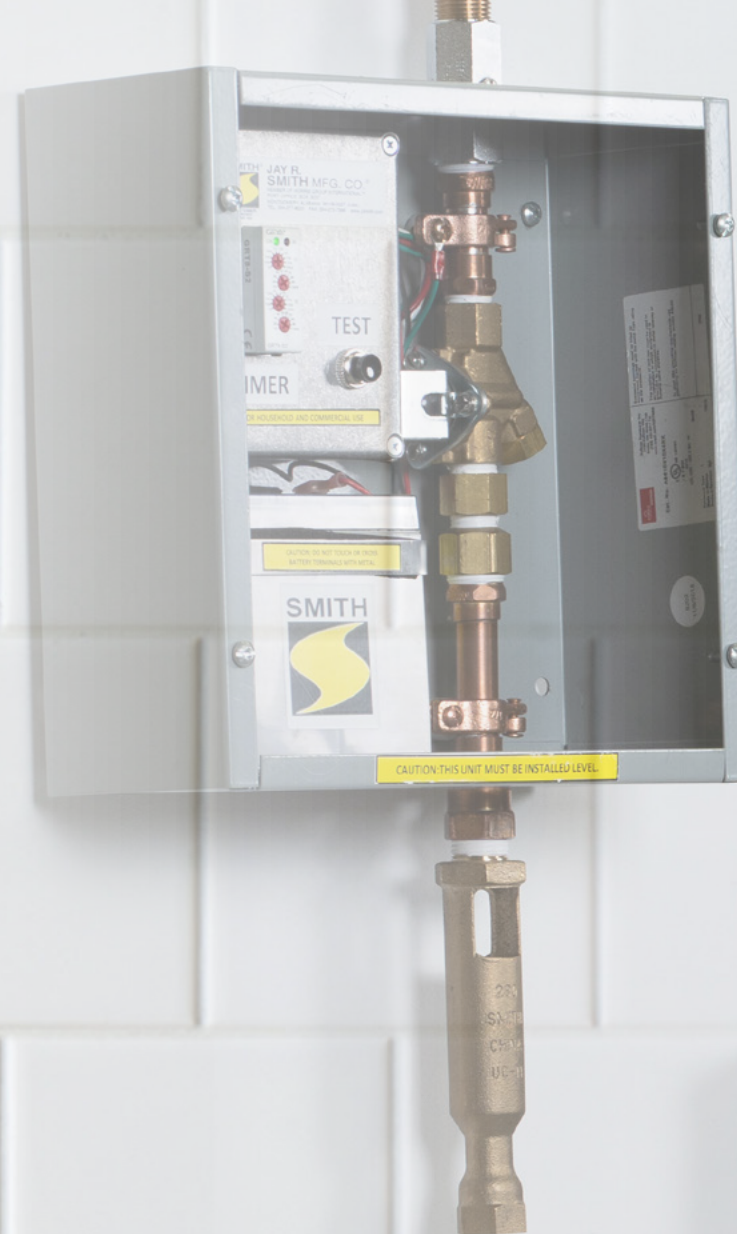



JRSMITH.COM

LABOR SAVINGS®

Smith's Contractor Labor Saving products are designed with the installer in mind. These products save time, require less manpower, and make the contractor's job more efficient.



QUARTERBACK® WATER CLOSET SUPPORT
FIGURE NO. M58-M54

ADJUSTABLE ROOF DRAIN
FIGURE NO. 1015



QUAD CLOSE® "STINK STOPPER"
TRAP SEAL DEVICE
FIGURE NO. 2692





LARSEN'S

SINCE 1958

Larsen's is one of the most experienced fire equipment cabinet manufacturers in the United States. The company began in 1928 as a metal job shop. In the 1960s we created our own branded line of fire cabinets that were both effective and architecturally pleasing, unlike the other products on the market at the time.

Over the years, we have been continually innovating with material, design options, and specialized features for specific applications. This has made our fire extinguisher, hose and valve cabinets a true specified, architectural piece of equipment and a favorite of building owners, designers and architects.

However, people do not specify our cabinets just because they are pretty. They turn to us because we offer an unsurpassed level of quality across our entire product line. That line now includes fire extinguisher cabinets, hose and valve cabinets, fire blanket cabinets, detention fire equipment cabinets, marine and industrial cabinets, and a complete line of access panels.

Customer service is our cornerstone, and we hold on to our small-business roots. One call gets you all the answers you need.



OCCULT SERIES
MODEL NO. SS 0-2409 V-DUO



MEDALLION SERIES
MODEL NO. BZ 2409-6R V-DUO



ARCHITECTURAL SERIES
MODEL NO. 2712-R Solid w/ Recessed Handle



LARSENSMFG.COM



CROKER.COM

In 1911, Chief Edward F. Croker of the New York City Fire Department resigned from the force after 27 years of service. He tendered his resignation as a result of the tragic Triangle Shirtwaist Factory Fire; he felt he could be of greater service by putting his wealth of experience “at the immediate disposal of the public in order that it may be applied to the other end of our common problem—the prevention of fire.”

Since 1911, Croker Fire Prevention has been a trusted name in the fire prevention industry. Manufacturing a wide range of products from fire hoses to extinguisher cabinets and everything in between, Croker spans the breadth of the industry.

We at Croker rely on the expertise of our employees to continually develop innovative new fire protection products. For more than a century, Croker Fire Prevention has been the trusted name for quality fire prevention products.



Chief Edward F. Croker



CROKER SINCE 1911



FIRE-TMEND
SINCE 1930

FIRE-END.COM



In 1930, Anthony J. Sposato, Sr. founded Fire-End. In the beginning, Fire-End's main business was selling and servicing fire extinguishers and providing municipal firefighting supplies to New England dealers.

In 1946, Anthony Sposato, Sr. handed the business off to his sons Anthony Sposato, Jr. and Joseph Sposato. Under their leadership, Fire-End grew to become a dominant leader in the field of fire equipment.

Today, Fire-End remains a third generation Sposato family business under the leadership of Paul Sposato. Our products are used throughout the world in municipal and interior fire equipment markets. Today, Fire-End distributes safety gear not only to firefighters, but also to EMS, Law Enforcement, and Military professionals, among others, making Fire-End truly "The end-all in fire safety."



Murdock is a sixth-generation, family-run company that has always had one goal—access to clean, safe drinking water for all.

When you turn to us for drinking fountains, bottle fillers, water coolers, or hydrants, you get nearly 170 years of experience, knowledge, and innovation. To this very day when you call us, you can get a Murdock on the phone.

No matter where you go in the world, you've probably had a drink from a Murdock product, whether from an antique fountain installed at the turn of the 20th century or a brand-new, high-tech bottle filler in your child's school. You may even have watered your flowers from a hydrant installed at a veteran's cemetery.

We will continue to develop high-quality, innovative products that ensure all living things on our planet have access to safe water.

**ALL-IN-ONE
Wash-N-Go![®]
OUTDOOR HAND
WASHING STATION
MODEL NO. GWQ84**



**H2O-TO-GO![®] EZREACH[™] COMPACT,
REFRIGERATED, SENSOR-OPERATED
WATER REFILL STATION
BFEZ168 SERIES**



**TOUCHLESS BI-LEVEL DRINKING
FOUNTAIN WITH BOTTLE FILLER
MODEL NO. A172408F-UG-VR-BF12-BCD**

MURDOCK[®]
SINCE 1853





POTTERROEMER.COM

Potter-Roemer's history is very similar to that of Acorn Engineering Company. We started in 1937 as a manufacturer's representative agency, but in our case, we were representing fire protection equipment.

Today, Potter-Roemer is the recognized leader in fire protection equipment. In industrial, commercial, institutional, and high-rise buildings, water pressure control is crucial for fighting fires. Installing contractors of these types of structures turn to us for their fire protection needs.

The advantage of Potter-Roemer is that we engineer and manufacture all components of our products, starting with a sheet of metal. Our sheer size allows us to offer the best prices for our customers.

We like to think of ourselves as an old company with young ideas. We are always looking for ways to improve our current line and add new items to our offerings based on the needs of our customers and the contractor.

POTTER ROEMER FAMILY OF PRODUCTS



SINCE 1937

POTTER ROEMER®



BestCare®

LIGATURE-RESISTANT PRODUCTS
DIGNITY SUITE™

Since 1946, Whitehall Healthcare has focused exclusively on providing plumbing solutions to meet the unique needs of our healthcare clients.

Our products are engineered, designed, and manufactured to aid in the efficient delivery of high-quality care to patients in hospitals, behavioral healthcare facilities, addiction treatment centers, and clinics.

Not only do we consider the provider's needs to be the driver behind our product creation, we hold the patients' best interests in mind as well through our use of Universal Design principles.

We strive to take the stigma out of the healthcare system with aesthetically pleasing ADA- and bariatric-compliant fixtures and accessories that are also ligature-resistant, in order to offer greater protection to the most vulnerable patients.



W.D. MANOR ALL-INCLUSIVE
DIALYSIS BOX
MODEL NO. 8193



PATIENT CARE UNIT
MODEL NO. 4030 SERIES



ONE STATION ADA COMPLIANT
COMPACT SCRUB SINK
MODEL NO. 4121ADA SERIES



WHITEHALL MANUFACTURING®

SINCE 1946



WHITEHALLREHABILITATION.COM

Whitehall Manufacturing® got its start during World War II as a key manufacturer of the rehabilitation whirlpool to aid in the recovery of injured soldiers.

Since 1946, the rehab side of our business has expanded, but remains focused on providing tools for injury recovery. We serve physical therapy, occupational therapy, podiatry, chiropractic, oncology, and long-term care providers as well as spa facilities.

One of our largest growing markets is sports medicine and rehabilitation. If you have ever seen a whirlpool in the background during an interview with an athlete after a big game, it was most likely a Whitehall® whirlpool. In fact, we provide the largest full-body tank on the market today.

We will continue to engineer, design, and manufacture rehab products to meet the needs of athletes and healthcare providers around the globe.



STATIONARY WHIRLPOOL
MODEL NO. S-110-S



cleatPRO®
MODEL NO. T-12-M-CC-EG22



MOBILE THERMALATORS
MODEL NO. T-12-M-EG22

STAINLESS STEEL TRAINING STAIRS
MODEL NO. TS-200



WHITEHALL® REHAB

SINCE 1946





ACORN BEEKEEPING EQUIPMENT
 Manufacturer of Beekeeping Frames
 13818 Oaks Avenue • Chino, CA 91710, U.S.A.
 Tel. 877-255-6078
 www.acornbee.com



ACORN CONTROLS
 Manufacturer of Thermostatic Mixing Valves & Controls
 15125 Proctor Ave. • City of Industry, CA 91746, U.S.A.
 Tel. 800-488-8999 • 626-336-4561
 www.acorneng.com



ACORN ENGINEERING COMPANY
 Manufacturer of Engineered Products
 15125 Proctor Ave. • City of Industry, CA 91746, U.S.A.
 Tel. 800-488-8999 • 626-336-4561
 www.acorneng.com



ACORN ENGINEERED SYSTEMS
 Manufacturer of Engineered Systems
 15125 Proctor Ave. • City of Industry, CA 91746, U.S.A.
 Tel. 800 488-8999 • 775 224-1151
 www.acorn-aes.com



ACORN-GENCON PLASTICS, LLC
 Injection Molded Products
 13818 Oaks Avenue • Chino, CA 91710, U.S.A.
 Tel. 909-591-8461
 www.acorn-gencon.com



ACORN THORN
 Manufacturer Representative
 Unit 5, Bearly Court, Baird Road,
 Waterwells Business Park
 Quedgeley Gloucester GL2 2AF, United Kingdom
 Tel. +44-1452-721211
 www.acornthorn.co.uk



ACORN SAFETY
 Manufacturer of Emergency Drench Equipment
 15125 Proctor Ave. • City of Industry, CA 91746, U.S.A.
 Tel. 800-488-8999 • 626-336-4561
 www.acorneng.com



ACORNVAC, INC.
 Vacuum Plumbing Systems
 13818 Oaks Avenue, Chino, CA 91710, U.S.A.
 Tel. 800-591-9920 • 909-902-1141
 www.acornvac.com



CHRONOMITE LABORATORIES, INC.
 Tankless Electric Water Heaters
 17451 Hurley Street • City of Industry, CA 91746, U.S.A.
 Tel. 800-447-4962 • 626-937-4270
 www.chronomite.com



CROKER
 Fire Protection Equipment
 7 Westchester Plaza • Elmsford, NY 10523
 Tel. 914-592-3640 • 800-759-3473 (USA only)
 www.croker.com



FIRE-END
 Fire Protection Equipment
 7 Westchester Plaza • Elmsford, NY 10523
 Tel. 914-592-3640 • 800-759-3473 (USA only)
 www.fire-end.com



ELMCO & ASSOCIATES
 Manufacturer Representative, Office,
 and Distribution Center
 8336 Valdez Ave. • Sacramento, CA 95828, U.S.A.
 Tel. 916-383-0110
 www.elmcoassoc.com



ELMCO SILVER STATE
 Manufacturer Representative, Office,
 and Distribution Center
 5022 Bond St. • Las Vegas, NV 89118, U.S.A.
 Tel. 702-871-1966
 www.elmcosilverstate.com



ELMCO STEWART
 Manufacturer Representative, Office,
 and Distribution Center
 3201 W Virginia Ave #5 • Phoenix, AZ 85009
 Tel. 602-269-0585
 15070 Proctor Ave • Industry, CA 91746
 Tel. 626-333-9942
 9040 Carroll Way, Suite 1 • San Diego, CA 92121
 Tel. 858-437-0112
 www.elmcostewart.com



ELMDOR STONEMAN
 Manufacturer of Access Doors & Roof Hatches
 17451 Hurley St. • La Puente, CA 91744, U.S.A.
 Tel. 626-968-8699
 www.elmdorstoneman.com



ELMCO SWORDS
 Manufacturer Representative and Office
 94-33 Ukee St. #4, Waipahu, HI 96797, U.S.A.
 Tel. 808-676-5475
 www.elmcoswords.com



ENGINEERED SOLUTIONS CANADA
 Manufacturer Representative, Office,
 and Distribution Center
 321 Cityview Blvd Unit #4 • Vaughan, ON
 L4H 3M3 Canada
 Tel. +1-905-832-0909 / +1-844-574-0909
 www.engineered-solutions.ca



FABRICACIÓN Y MANUFACTURAS DE MÉXICO S.A. DE C.V.
 Central and Latin America Manufacturing
 Maquiladoras #1387-1 Col.Cd. Industrial Tijuana, B.C.,
 C.P. 22444, Mexico • Tel. 011-52-664-623-4580
 www.morrisgroup.co



JAY R. SMITH MFG. CO.
 Plumbing and Drainage Products
 2781 Gunter Park Dr. E. • Montgomery, AL 36109, U.S.A.
 Tel. 800-467-6484 • 334-277-8520
 www.jrsmith.com



SMITH CHROME PLATING
 Chrome Plating Services
 2781 Gunter Park Dr. E. • Montgomery, AL 36109, U.S.A.
 • Tel. 800-467-6484 • 334-277-8520 x275
 www.smithplating.com



LARSEN'S MANUFACTURING
 Manufacturer of Fire Protection Equipment
 7421 Commerce Lane N.E. • Minneapolis, MN 55432,
 U.S.A. • Tel. 800-527-7367 • 763-571-1181
 www.larsensmfg.com



MORRIS GROUP DUBAI
 Middle East Sales
 Warehouse # FZS2AA05 • Jabal Ali Free Zone, Dubai,
 United Arab Emirates • Tel. 971-4-8806528/29
 www.morrisdubai.com



MORRIS INDUSTRIES MÉXICO, S. DE R.L. DE C.V.
 Central and Latin America Sales
 Maquiladoras #1387-1 Col.Cd. Industrial Tijuana, B.C.,
 C.P. 22444, Mexico • Tel. 011-52-664-623-4580
 www.morrisgroup.co



MORRIS/LEE
 Manufacturer Representative, Office,
 and Distribution Center
 321 Cityview Blvd, Unit #4 • Vaughan, ON L4H 3M3,
 Canada • Tel. 844-574-0909
 www.morrisleecan.com



MURDOCK MANUFACTURING
 Drinking Fountains, Hydrants, Bottle Fillers, Restroom
 Fixtures and Accessories
 15125 Proctor Ave. • City of Industry, CA 91746, U.S.A.
 Tel. 800-45-DRINK • 626-333-2543
 www.murdockmfg.com



POTTER ROEMER
 Fire Protection Equipment
 17451 Hurley Street • City of Industry, CA 91746, U.S.A.
 Tel. 800-366-3473 • 626-616-4740
 www.potterroemer.com



FIREPRO
 Fire Protection Equipment
 15062 Proctor Ave. • City of Industry, CA 91746, U.S.A.
 Tel. 877-917-5800 • 626-616-4740
 www.firepromonitors.com



WHITEHALL MANUFACTURING
 Healthcare and Rehabilitation Products
 15125 Proctor Ave. • City of Industry, CA 91746, U.S.A.
 Tel. 800-782-7706 • 626-968-6681
 www.whitehallmfg.com



MORRIS GROUP INTERNATIONAL®
 www.morrisgroup.co